

# Graphene Oxide Doped SU-8 Waveguide and Its Application as Saturable Absorber

Volume 9, Number 5, October 2017

Khairul Zafri Mustafa  
Wu Yi Chong  
Mohd Haniff Ibrahim  
Yuen Kiat Yap  
Fauzan Ahmad  
Choon Kong Lai  
Nur Afiqah Mohd Ariffin  
Harith Ahmad

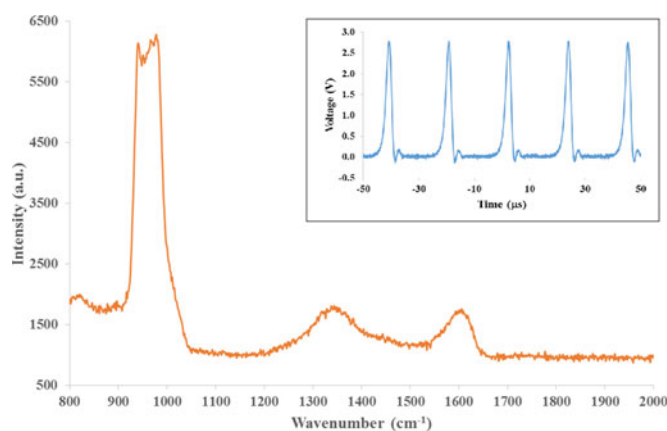

DOI: 10.1109/JPHOT.2017.2752280

1943-0655 © 2017 IEEE

# Graphene Oxide Doped SU-8 Waveguide and Its Application as Saturable Absorber

Khairul Zafri Mustafa,<sup>1</sup> Wu Yi Chong,<sup>2</sup> Mohd Haniff Ibrahim,<sup>1</sup>  
Yuen Kiat Yap,<sup>3</sup> Fauzan Ahmad,<sup>4</sup> Choon Kong Lai,<sup>2</sup>  
Nur Afiqah Mohd Ariffin,<sup>2</sup> and Harith Ahmad<sup>2</sup>

<sup>1</sup>Faculty of Electrical Engineering, Universiti Teknologi Malaysia, Johor Bahru  
81310, Malaysia

<sup>2</sup>Photonics Research Center, University of Malaya, Kuala Lumpur 50603, Malaysia

<sup>3</sup>Heriot-Watt University Malaysia, Putrajaya 62200, Malaysia

<sup>4</sup>Malaysia-Japan International Institute of Technology, Universiti Teknologi Malaysia, Kuala Lumpur 54100, Malaysia

DOI:10.1109/JPHOT.2017.2752280

1943-0655 © 2017 IEEE. Translations and content mining are permitted for academic research only.

Personal use is also permitted, but republication/redistribution requires IEEE permission.

See [http://www.ieee.org/publications\\_standards/publications/rights/index.html](http://www.ieee.org/publications_standards/publications/rights/index.html) for more information.

Manuscript received June 22, 2017; revised September 7, 2017; accepted September 9, 2017. Date of publication September 14, 2017; date of current version October 2, 2017. This work was supported in part by the UTM Student Research Grant Vot Project, R.J.130000.7823 R.J130000.7823.4F317, AOARD under Grant FA2386-16-1-4016 and the Malaysia Ministry of Higher Education under Grant LRGS(2015)/NGOD/UM/KPT. Corresponding author: Wu Yi Chong (e-mail: wuyi@um.edu.my).

**Abstract:** Graphene oxide (GO)-doped SU-8 waveguides have been fabricated and characterized. The GO-doped SU-8 can be processed using standard photolithography parameters. The optical characteristics of the developed waveguides are determined using fibre-butt coupling and cut-back method. Propagation loss of 1.9 dB/cm and a coupling loss of 4 dB per point measured at 1550 nm wavelength are obtained. Q-switched laser operation is achieved by inserting a 3 mm GO-doped SU-8 waveguide into a ring fibre laser configuration, making it a potential candidate as integrated saturable absorber for on-chip polymer waveguide applications.

**Index Terms:** Graphene oxide, SU-8 polymer, optical waveguide, saturable absorber.

## 1. Introduction

In recent years, there is an increasing exploration of graphene and its derivatives, namely graphene oxide (GO) and reduced graphene oxide (rGO), in various research fields. Based on graphene's unique electrical, optical, and chemical properties, many scientific and engineering studies have been carried out, demonstrating their potential as alternative materials for existing and new applications. Studies on their performance as sensors, photodetectors, light emitting diode, pulsed laser saturable absorber (SA) and broadband polarisers have been carried out [1]–[7].

GO contains approximately 70% carbon and 30% oxygen, with both  $sp^2$  and  $sp^3$  hybridisation honeycomb structures [8]. GO contains several functional groups such as carboxylic and carbonyls located at its edges, as well as hydroxyl and epoxy group on its surface [9], [10]. These functional groups contribute to GO's unique hydrophilic and electrical insulating properties, which can be controlled by manipulating the oxygen content [11], [12]. Applications of GO in photonics include its use as SA in pulsed fibre laser [13], and as functional element in optical waveguide polariser and modulator [14]–[16]. Results have been promising where the pulsed laser performance is comparable to that of graphene-based SA [13]. On the other hand, waveguide polarisers with

polarisation extinction ratio of more than 40 dB and operation bandwidth covering the entire optical fibre communication transmission window has also been demonstrated [17]. In all demonstrations above, integration of GO with the optical waveguide is extrinsic, where the GO film is inserted in the light propagation path or coated onto the waveguide core surface. It is of great interest if GO can be incorporated (or doped) into the waveguide material which will simplify the fabrication processes as well as increase their interaction strength with light. Cao et al. have demonstrated the incorporation of GO into polyimide, which shows promising thermo-optic properties with the potential to be used for optical switching [18]. The possibility of incorporating GO directly into the waveguide material will open up a new dimension in the study and application of new photonics functions.

In this work, we demonstrate the ability of doping GO into a polymer waveguide material, which is SU-8 polymer. Standard photolithography and wet chemical development processes were used to produce the GO doped SU-8 waveguide. The effect of GO doping on SU-8 waveguide fabrication parameters as well as its characteristics are studied. To demonstrate the application of GO doped SU-8 waveguide, it is inserted into a ring fibre laser cavity to act as SA. Q-switching operation of the fibre laser was observed with pulse characteristics similar to those using conventional SA insertion method. The GO functionalised SU-8 polymer has potential application in integrated photonics devices.

## 2. Experimental Methods

Incorporation of GO into SU-8 polymer follows these steps: Graphene oxide solution (dispersed in DI water) is synthesised using modified Hummer's method. The synthesis process is described in [19]. The GO sheet size produced ranges from 0.1–1.0  $\mu\text{m}$ , measured using atomic force microscopy. The GO solution was dropped onto a glass plate and allowed to dry at room temperature for one day. The dried GO film was then physically removed from the glass plate carefully using the edge of a Teflon coated spatula and 3.5 mg of GO flakes - measured using electronic weighing balance - was mixed with 10 mL of cyclopentanone, which is the solvent for SU-8 polymer. The solution was dispersed using ultrasonication for about 10 minutes. A homogenous solution mixture of GO and cyclopentanone was produced after this process. 1.5 mL of the GO-cyclopentanone solution was then mixed with 1.5 mL of SU-8 2010 and the mixture solution was ultrasonicated again for 20 minutes. Different concentrations of GO doped SU-8 polymer were prepared by varying the weight of GO flakes.

Photolithography and wet chemical etching process steps were next employed to fabricate the waveguides. A silicon wafer with a  $\text{SiO}_2$  undercladding layer of 7  $\mu\text{m}$  thick and refractive index of 1.444 measured at 1550 nm was placed on a spin coater. 1 mL of GO doped SU-8 polymer solution was applied onto the wafer and spun for 1 minute at 4000 rpm to obtain a GO doped SU-8 layer. The wafer then underwent soft-bake process at 95 °C for 3 minutes to remove excessive solvent [20]. After soft-bake, the wafer was allowed to cool down to room temperature before performing photolithography. Contact-type UV mask aligner and negative mask with straight channels pattern were used. UV exposure duration was set at 8 seconds. After UV exposure, the wafer underwent post-exposure-bake (PEB) at 95 °C for 4 minutes, and was then allowed to cool down to room temperature. Chemical development process ensued by immersing the wafer in SU-8 developer for about 10 seconds to remove the unexposed region of the GO doped SU-8 layer during photolithography process. Once this was completed, the wafer was dried using nitrogen gas flow to remove residue chemical developer. Norland NOA 65 UV resin was then spin-coated onto the waveguide and cured to form protection overcladding layer.

Both ends of the developed waveguide chip were diced using cleave-and-break method. The diced waveguide was then placed on a waveguide holder. Input and output fibres were then aligned to both ends of the waveguide using 5-axis manual alignment stages (Newport 562-M Ultralign positioning stages). Fig. 1 shows the arrangement of the waveguide characterisation setup. A 1550 nm laser source (ANDO AQ4321 tunable laser source) was used as input. The output power was measured using an optical power meter (Thorlabs S144C). Light was coupled into the waveguide using SMF-28 fibre pigtails spliced to high numerical aperture fibres (Nufern UHNA-4) to reduce light

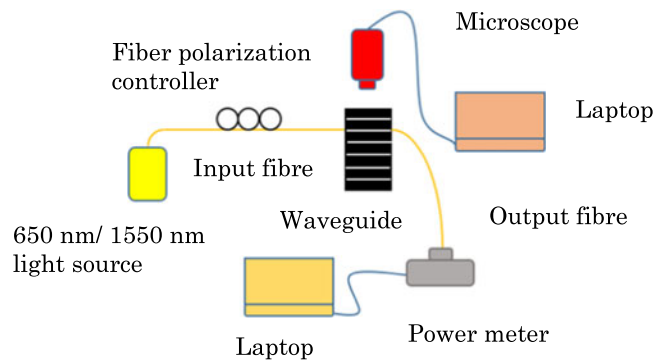

Fig. 1. Set up for waveguide characterisation.

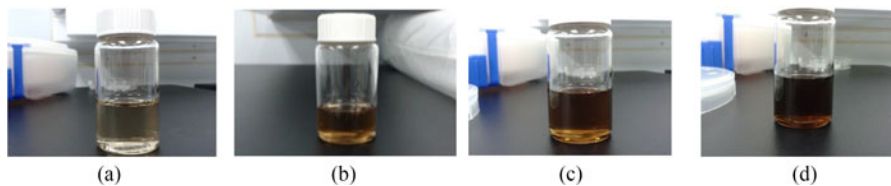

Fig. 2. GO-cyclopentanone mixture solutions with GO concentration of (a) 0.07 mg/mL, (b) 0.22 mg/mL, (c) 0.35 mg/mL and (d) 0.52 mg/mL.

coupling loss. A polarisation controller (PC) was placed between the laser source and the waveguide to control the polarisation state of the input light into the waveguide to measure polarisation dependent loss. Cut-back method was used to obtain the propagation loss as well as coupling loss of the developed waveguides [21], [22].

To assess the viability of the GO-doped SU-8 waveguide as an optical SA material, a 3 mm long waveguide was inserted into a ring fibre laser resonator used in our previous work [23], with 20% of the resonator power tapered out as the laser output power while 80% of light is looped back into the laser cavity. The pump laser wavelength is 980 nm and the gain medium is a 4 m long erbium doped fibre (FibreCore Metrogain M-12). The laser output power was measured using optical power meter (Thorlabs S144C), while the temporal response of the laser was measured using a photodetector (Thorlabs PDA50B-EC) connected to an oscilloscope.

### 3. Results and Discussion

Fig. 2 shows images of GO-cyclopentanone mixture solutions produced by mixing different weight of GO with 10 mL of cyclopentanone. It can be seen that the mixture solutions are brownish in colour, and become more intense with increasing GO concentration. At solution concentration of 0.52 mg/mL, the GO solution is almost non-transparent and it is not certain if there is GO precipitation. Therefore, only GO solutions with concentration of 0.07 mg/mL, 0.22 mg/mL and 0.35 mg/mL were used for subsequent production of GO doped SU-8 film with GO concentration ranging from 0.01 wt.% to 0.05 wt.%. The refractive index and thickness of the spin-coated films were then measured using prism coupler.

The effect of GO concentration on the thickness and refractive index of the spin-coated GO doped SU-8 films are shown in Fig. 3. The SU-8 refractive index is expected to increase with the inclusion of GO due to higher light absorption and the higher refractive index of GO. As shown in Fig. 3(a), the refractive index of the GO doped SU-8 film increases with increasing GO concentration. For pure SU-8 film, the refractive index is about 1.5702. With GO concentration of 0.01 wt.%, the refractive

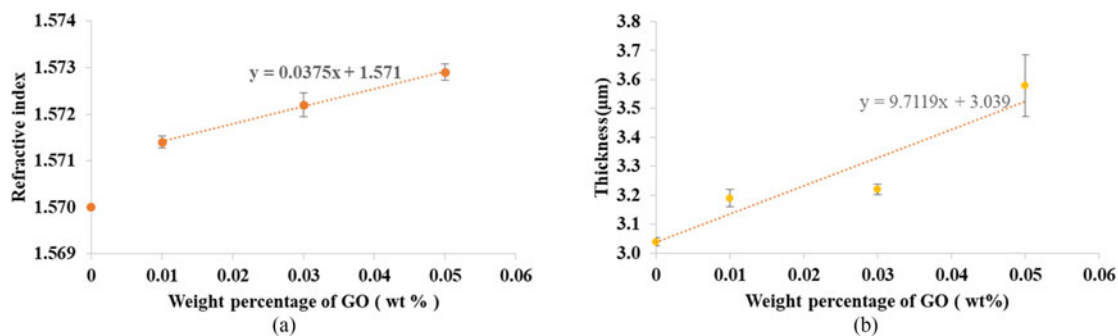

Fig. 3. (a) Refractive index and (b) thickness of SU-8 film with different GO concentration.

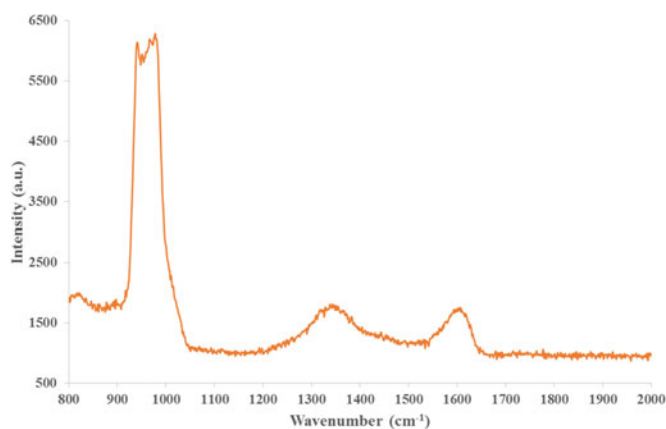

Fig. 4. Raman spectrum of GO-doped SU-8 polymer waveguide.

index of the SU-8 film appears to have a step increase to about 1.5714, which then increases linearly to 1.5722 and 1.5728 when the GO concentration are 0.03 wt.% and 0.05 wt.% respectively.

On the other hand, the thickness of the GO doped SU-8 film also increases with GO concentration as shown in Fig. 3(b). The relationship between GO concentration with SU-8 film thickness is estimated to be  $9.72 \mu\text{m}/\text{wt.}\%$ , though with limited data points in the current work, this value cannot be established with better certainty. Nevertheless, the inclusion of GO into SU-8 does seem to affect the resulting SU-8 film thickness produced using spin coating technique, believed to be due to the increased viscosity of SU-8 polymer.

The Raman spectrum of the GO-doped polymer is shown in Fig. 4. The intense peak at around  $960 \text{ cm}^{-1}$  is due to the symmetric stretching vibration of the C-O-C bond in the SU-8 polymer [24]. The spectrum also registers two signature peaks of GO, which are  $1356 \text{ cm}^{-1}$  and  $1610 \text{ cm}^{-1}$  respectively. The  $I_D$  to  $I_G$  ratio of the peaks is 1.03, indicating the existence of GO in the SU-8 polymer.

GO doped SU-8 film with GO concentration of 0.05 wt.% was used to develop straight channel waveguides for optical waveguide characterisation. During photolithography process, standard process parameters such as soft-bake and PEB temperature and duration, as well as UV exposure duration were used. Development of the GO doped SU-8 waveguide was observed to be similar to the development of pure SU-8 waveguide, with no difficulties encountered during chemical development. Therefore, the inclusion of GO into SU-8 has negligible effects on its process parameters.

Fig. 5 shows the insertion loss of GO doped SU-8 waveguide with different waveguide lengths. The propagation loss of the waveguide obtained from the gradient of the graph is  $1.9 \text{ dB}/\text{cm}$ , while the total coupling loss of the waveguide, obtained as the Y-intercept of the graph is

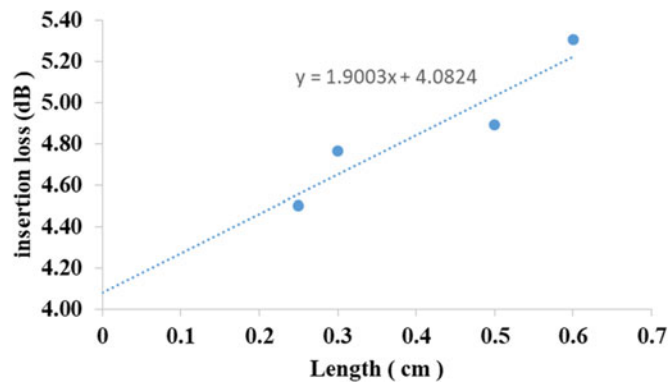

Fig. 5. Graph of cut-back method of GO doped SU-8 channel waveguide.

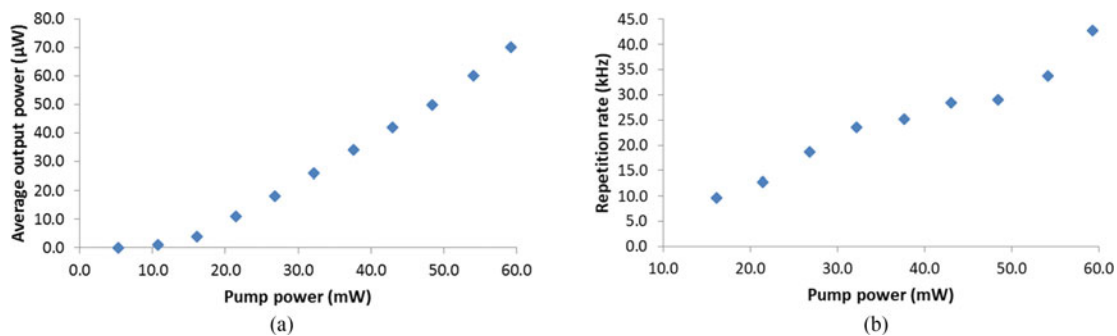

Fig. 6. (a) Change in laser output power with increasing pump power and (b) Repetition rate of Q-switched fibre laser with different pump power.

about 4 dB. The coupling loss is attributed to a combination of core index and numerical aperture (NA) mismatch losses. The propagation loss is similar to SU-8 waveguide without GO doping. Therefore, incorporation of GO into SU-8 does not induce significant excess loss to the waveguide, at least at the characterization wavelength of 1550 nm. On the other hand, the polarisation dependent loss was measured to be less than 1 dB. This is in contrast to earlier reports on the optical behaviour of graphene functionalized optical waveguides, which show large polarisation effects [6], [15], [17]. In these previous report, the graphene or GO were coated on one side of the waveguide and forms a planar layer parallel to the waveguide propagation direction. It is believed that in the current work, GO is dispersed uniformly and with random orientation in the SU-8 film, thus reducing the polarising effect of GO. The polarisation insensitive waveguide produced using GO doped SU-8 may allow other characteristics of GO to be explored without the concern of large anisotropic dielectric function of the material.

The performance of GO-doped SU-8 waveguide as SA is shown in Fig. 6. Continuous wave (CW) laser oscillation started at pump power of 12.0 mW. When the pump power was increased to about 16.0 mW, laser pulsing was observed. Fig. 6(a) shows the average output power of the fibre laser at different pump power levels. The average output power increases linearly with the pump power, with a maximum of about 70.0  $\mu$ W achieved at a maximum pump power of 60 mW. The slope efficiency is calculated to be 0.15%, which is low compared to other fibre laser demonstrations. This can be attributed to the high coupling loss between the optical fibres and the GO-doped SU-8 waveguide. For a 3 mm long GO-doped SU-8 waveguide, the insertion loss is about 4.8 dB. In addition, the splice loss between UHNA-4 fibre and SMF-28 fibre is about 1 dB per point. Therefore, the total insertion loss of the GO-doped SU-8 waveguide in the fibre laser cavity is about 6.8 dB. Insertion loss can be reduced using fibres with better NA and index matching. In addition, the splice loss

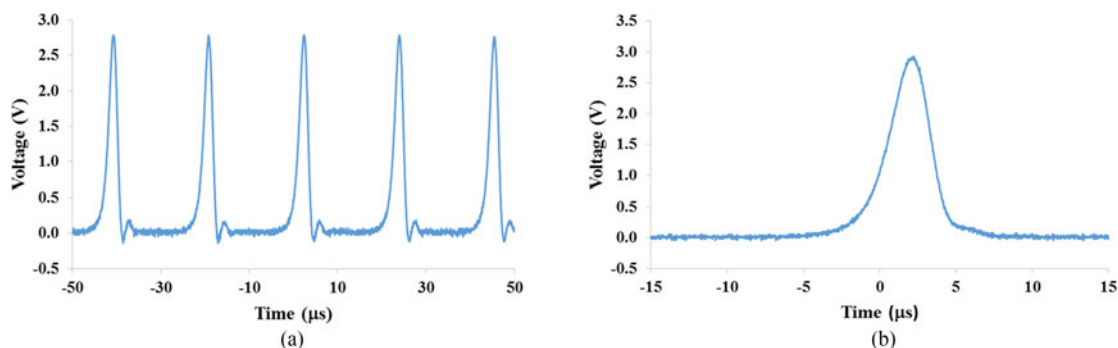

Fig. 7. (a) Pulse train and (b) Pulse profile of the Q-switched laser at pump power of 60 mW.

between the high NA fibre and standard SMF-28 fibre can also be improved by optimising the fusion splicing parameters.

Repetition rate of the pulsed laser increases with pump power as shown in Fig. 6(b), indicating Q-switching operation. At the maximum pump power of about 60.0 mW, the repetition rate and pulse width obtained were 43.0 kHz and 3.9  $\mu\text{s}$  respectively, as shown in Fig. 7. Increasing the pump power beyond 60 mW causes the Q-switching operation to become unstable. As the waveguide width and height are 3  $\mu\text{m}$  and 3.5  $\mu\text{m}$  respectively, it can support a number of higher order transverse modes. It is anticipated that these higher order modes may affect the stability of the Q-switched fibre laser. Nevertheless, this demonstration opens up the potential for the development of planar waveguide chip-based pulsed laser source.

#### 4. Conclusion

GO doped SU-8 waveguides have been fabricated and characterized. Standard photolithography and process was employed to develop the waveguide. The propagation loss of the fabricated waveguide is 1.9 dB/cm with 4 dB of total coupling loss. The fabricated waveguides show insignificant polarisation dependent loss. Using the GO doped SU-8 waveguide as SA in a ring fibre laser, Q-switched laser was achieved. The maximum repetition rate and pulse duration were measured to be 43.0 kHz and 3.9  $\mu\text{s}$  respectively, at maximum pump power of 60 mW. The successful inclusion of GO into SU-8 polymer opens up a new dimension in the application of GO in integrated optical circuit devices.

#### References

- [1] W. Li *et al.*, "Reduced graphene oxide electrically contacted graphene sensor for highly sensitive nitric oxide detection," *ACS Nano*, vol. 5, pp. 6955–6961, 2011.
- [2] H. J. Yoon, J. H. Yang, Z. Zhou, S. S. Yang, and M. M.-C. Cheng, "Carbon dioxide gas sensor using a graphene sheet," *Sensors Actuators B, Chem.*, vol. 157, pp. 310–313, 2011.
- [3] F. Xia, T. Mueller, Y.-M. Lin, A. Valdes-Garcia, and P. Avouris, "Ultrafast graphene photodetector," *Nature Nanotechnol.*, vol. 4, pp. 839–843, 2009.
- [4] T. Mueller, F. Xia, and P. Avouris, "Graphene photodetectors for high-speed optical communications," *Nature Photon.*, vol. 4, pp. 297–301, 2010.
- [5] J. Wu *et al.*, "Organic light-emitting diodes on solution-processed graphene transparent electrodes," *ACS Nano*, vol. 4, pp. 43–48, 2009.
- [6] Q. Bao *et al.*, "Broadband graphene polarizer," *Nature Photon.*, vol. 5, pp. 411–415, 2011.
- [7] Y. H. Hu, H. Wang, and B. Hu, "Thinnest two-dimensional nanomaterial—Graphene for solar energy," *ChemSusChem*, vol. 3, pp. 782–796, 2010.
- [8] Y. Chang *et al.*, "In vitro toxicity evaluation of graphene oxide on A549 cells," *Toxicol. Lett.*, vol. 200, pp. 201–210, 2011.
- [9] K. Haubner *et al.*, "The route to functional graphene oxide," *ChemPhysChem*, vol. 11, pp. 2131–2139, 2010.
- [10] S. Stankovich *et al.*, "Graphene-based composite materials," *Nature*, vol. 442, pp. 282–286, 2006.
- [11] Y. Si and E. T. Samulski, "Synthesis of water soluble graphene," *Nano Lett.*, vol. 8, pp. 1679–1682, 2008.

- [12] J. Paredes, S. Villar-Rodil, A. Martínez-Alonso, and J. Tascon, "Graphene oxide dispersions in organic solvents," *Langmuir*, vol. 24, pp. 10560–10564, 2008.
- [13] G. Sobon *et al.*, "Graphene oxide vs. reduced graphene oxide as saturable absorbers for Er-doped passively mode-locked fiber laser," *Opt. Exp.*, vol. 20, pp. 19463–19473, 2012.
- [14] J. Koo, J. Park, Y.-W. Song, S. Lee, K. Lee, and J. H. Lee, "Fiber optic polarization beam splitter using a reduced graphene oxide-based interlayer," *Opt. Mater.*, vol. 46, pp. 324–328, 2015.
- [15] J. T. Kim and C.-G. Choi, "Graphene-based polymer waveguide polarizer," *Opt. Exp.*, vol. 20, pp. 3556–3562, 2012.
- [16] X. Zhao *et al.*, "Ultrafast carrier dynamics and saturable absorption of solution-processable few-layered graphene oxide," *Appl. Phys. Lett.*, vol. 98, 2011, Art. no. 121905.
- [17] W. Lim *et al.*, "Graphene oxide-based waveguide polariser: From thin film to quasi-bulk," *Opt. Exp.*, vol. 22, pp. 11090–11098, 2014.
- [18] T. Cao *et al.*, "A novel graphene oxide-polyimide as optical waveguide material: Synthesis and thermo-optic switch properties," *Opt. Mater.*, vol. 60, pp. 45–49, 2016.
- [19] Y. Yap, N. Huang, S. Harun, and H. Ahmad, "Graphene oxide-based Q-switched erbium-doped fiber laser," *Chin. Phys. Lett.*, vol. 30, 2013, Art. no. 024208.
- [20] S. Keller, G. Blagoi, M. Lillemose, D. Haefliger, and A. Boisen, "Processing of thin SU-8 films," *J. Micromech. Microeng.*, vol. 18, 2008, Art. no. 125020.
- [21] Y. Vlasov and S. McNab, "Losses in single-mode silicon-on-insulator strip waveguides and bends," *Opt. Exp.*, vol. 12, pp. 1622–1631, 2004.
- [22] S. J. McNab, N. Moll, and Y. A. Vlasov, "Ultra-low loss photonic integrated circuit with membrane-type photonic crystal waveguides," *Opt. Exp.*, vol. 11, pp. 2927–2939, 2003.
- [23] W. Y. Chong, Y. K. Yap, and H. Ahmad, "Low-threshold Q-switched erbium-doped fiber laser using molybdenum disulphide saturable absorber prepared through evaporitic formation," *IEEE Photon. J.*, vol. 7, no. 6, Dec. 2015, Art. no. 1503907.
- [24] Z.-J. Chen, J. Yao, Q.-J. Xu, and Z.-H. Wang, "Two-photon polymerization fabrication and Raman spectroscopy research of SU-8 photoresist using the femtosecond laser," *Optoelectron. Lett.*, vol. 13, pp. 210–213, 2017.